

# Professionall

Solutii profesionale pentru echipamente profesionale



**GAS COMPONENTS**



**ELECTRIC COMPONENTS**



**WATER TECHNOLOGY**



**MECHANICAL COMPONENTS**



**TOOLS**

Spare parts suitable for

# FOSTER



## heating elements

### heating elements for refrigeration

#### heating elements for defrosting



<b>No.</b>	417604	<b>Ref. No.</b>	15240023
<b>description</b>	heating element 140W 230V L 335mm W 135mm L1 30mm L2 305mm W1 105mm W2 30mm cable length 500mm tube ø 8.5mm		



<b>No.</b>	417603	<b>Ref. No.</b>	15240625
<b>description</b>	heating element 200W 230V L 250mm W 200mm L1 25mm L2 225mm W1 100mm W2 100mm cable length 500mm tube ø 8.5mm		

#### heating elements for condensate evaporation



<b>No.</b>	420434	<b>Ref. No.</b>	15843061
<b>description</b>	heating element 975W 240V L 1020mm W 70mm Hmm cable length 500mm tube ø 8mm		

### heating cables

#### drain heating cables



<b>No.</b>	378455	<b>Ref. No.</b>	00-556114
<b>description</b>	drain heating cable 6W 240V L 1700mm L1 (unheated) 1050mm L2 (heated) 650mm cable length 1700mm PVC Qty 1 connection 2-wire		

## thermostats

### refrigeration thermostats

#### RANCO

##### K50 series



<b>No.</b>	390581	<b>Ref. No.</b>	15315803
<b>description</b>	thermostat RANCO type K50-S3595 probe ø 2mm probe Lmm capillary pipe 2000mm		

## switches and momentary switches

### rocker/momentary rocker switches

#### 28x22mm



<b>No.</b>	301305	<b>Ref. No.</b>	15243562
<b>description</b>	rocker switch mounting measurements 28.5x22mm black 2NO 240V 16A 0-1 connection male faston 6.3mm ambient temperature max. 85/125°C protection IP44		



<b>No.</b>	301301 <sup>1</sup>	<b>Ref. No.</b>	15243564
<b>description</b>	rocker switch mounting measurements 28x22mm green 2NO 250V 20A illuminated connection male faston 6.3mm ambient temperature max. 85°C protection IP40		

<sup>1</sup>illuminated

#### 30x22mm



<b>No.</b>	301003	<b>Ref. No.</b>	15243565
<b>description</b>	rocker switch mounting measurements 30x22mm green 2NO 250V 16A illuminated 0-1 connection male faston 6.3mm ambient temperature max. 125/55°C protection IP65		

#### accessories for 301003



<b>No.</b>	301036	<b>Ref. No.</b>	—
<b>description</b>	protective cover internal size 30x22mm for rocker switch mounting measurementsmm		



## magnetic switches

## miscellaneous



1

<b>No.</b>	347629	<b>Ref. No.</b>	16240122
<b>description</b>	magnetic switch 250V 1NO connection plug L 800mm		

## encoders and potentiometers



1

<b>No.</b>	403521	<b>Ref. No.</b>	00-555396
<b>description</b>	encoder shaft L 15mm		

## alarm devices

## loudspeakers

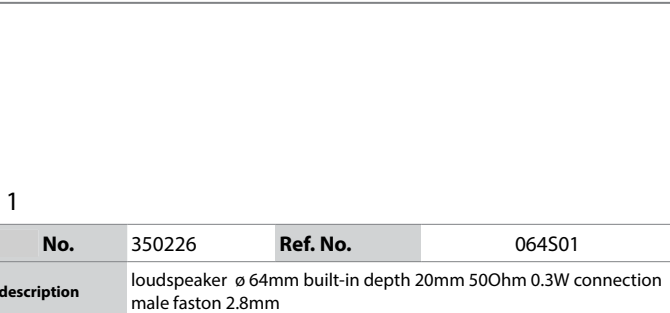

1

<b>No.</b>	350226	<b>Ref. No.</b>	064501
<b>description</b>	loudspeaker $\varnothing$ 64mm built-in depth 20mm 500hm 0.3W connection male faston 2.8mm		

## electronic controllers

## ELIWELL

## refrigeration controllers

## built-in version



1

<b>No.</b>	378495	<b>Ref. No.</b>	16250407
<b>description</b>	electronic controller ELIWELL type ID961LX mounting measurements 71x29mm 230V voltage AC NTC/PTC relay outputs 1 CO-8A(3) NTC/PTC DI built-in depth 59mm protection IP65 yes display 3 digits		

## LAE

## refrigeration controllers

## built-in version



1

<b>No.</b>	381376	<b>Ref. No.</b>	00556122
<b>description</b>	electronic controller LAE type 00-556122 mounting measurements 26x48mmV voltage relay outputs FOSTER front measurements 65x31.5mm built-in depth 50mm protection IP44 built-in version defr. funct.°C display		



1

<b>No.</b>	378489	<b>Ref. No.</b>	00-556223
<b>description</b>	electronic controller LAE type AT1-5BS6E-1FS mounting measurements 71x29mm 230V voltage AC NTC/PTC relay outputs 2 NO-16A(8) NO-7A(2) NTC/PTC NTC/PTC DI front measurements 77x35mm built-in depth 70mm protection IP55 yes -50 to +120°C display 3 digits		



1





<b>No.</b>	379764	<b>Ref. No.</b>	00-555848 00-556224 16270000
<b>description</b>	electronic controller LAE type AT2-5BS4E-AG mounting measurements 71x29mm 230V voltage AC NTC/PTC relay outputs 3 NO-16A(5) NO-7A(2) NO-7A(2) NTC/PTC NTC/PTC DI front measurements 77x35mm built-in depth 70mm protection IP55 accuracy 1% built-in version yes -50 to +120°C display 3 digits		





## accessories for 379764





<b>No.</b>	379780	<b>Ref. No.</b>	—
<b>description</b>	temperature probe NTC 10kOhm cable TPE probe -40 up to +110°C cable -40 up to +110°C probe $\varnothing$ 6x35mm cable length 1.5m without screw connection		
<b>No.</b>	379781	<b>Ref. No.</b>	—
<b>description</b>	temperature probe PTC 1kOhm cable thermoplastic probe -50 up to +150°C cable -40 up to +110°C probe $\varnothing$ 6x14mm cable length 1.5m without screw connection 2-wire		



built-in version 2-piece

 <p>71 x 29mm</p>			
<b>No.</b>	378450	<b>Ref. No.</b>	16240105
<b>description</b>	keypad unit LAE type LCD5-S mounting measurements 71x29mm built-in depth 20mm display 3 digits		
<b>spare parts for</b>	378450		
	<b>No.</b>	403459	<b>Ref. No.</b> —
	connection cable LAE type FC06-20M01		
<b>accessories for</b>	378450		
	<b>No.</b>	378253	<b>Ref. No.</b> —
	load module LAE type BD1-28C155W-B mounting measurements 107x95x47mm 230V voltage AC NTC relay outputs 5 NO-16A(12) NO-16A(4) NO-16A(4) NO-7A(2) NO-7A(2) NTC NTC DI DI built-in depth 47mm protection IP40 yes yes -50 to +120°C display		
	<b>No.</b>	403458	<b>Ref. No.</b> —
	load module LAE type BIT25B153E-A mounting measurements 88x85mm 230V voltage AC NTC relay outputs 3 NO-20A(8) NO-16A(4) NO-7A(2) NTC NTC DI DI front measurementsmm built-in depth 40mm protection IP55 yes yes -50 up to +110°C display		
	<b>No.</b>	403459	<b>Ref. No.</b> —
	connection cable LAE type FC06-20M01		

 <p>71 x 29mm</p>			
<b>No.</b>	379771	<b>Ref. No.</b>	00-555992
<b>description</b>	keypad unit LAE type LCD5-S mounting measurements 71x29mmV voltage relay outputs front measurements 77x35x20mm built-in depth 20mm protection IP55°C display 3 digits		
<b>accessories for</b>	379771		
	<b>No.</b>	378253	<b>Ref. No.</b> —
	load module LAE type BD1-28C155W-B mounting measurements 107x95x47mm 230V voltage AC NTC relay outputs 5 NO-16A(12) NO-16A(4) NO-16A(4) NO-7A(2) NO-7A(2) NTC NTC DI DI built-in depth 47mm protection IP40 yes yes -50 to +120°C display		
	<b>No.</b>	403458	<b>Ref. No.</b> —
	load module LAE type BIT25B153E-A mounting measurements 88x85mm 230V voltage AC NTC relay outputs 3 NO-20A(8) NO-16A(4) NO-7A(2) NTC NTC DI DI front measurementsmm built-in depth 40mm protection IP55 yes yes -50 up to +110°C display		
	<b>No.</b>	403459	<b>Ref. No.</b> —
	connection cable LAE type FC06-20M01		

			
<b>No.</b>	403413	<b>Ref. No.</b>	00555739 00-555920 00-556225
<b>description</b>	power PCB LAE type LF28B253E-1FS mounting measurements 104x91mm 230V voltage AC NTC relay outputs 3 NO-20A(6) NO-12A(4) NO-7A(2) NTC NTC DI DI front measurements 105x63mm built-in depth 45mm protection IP2x -50 up to +80°C display		
<b>accessories for</b>	403413		
	<b>No.</b>	379771	<b>Ref. No.</b> 00-555992
	keypad unit LAE type LCD5-S mounting measurements 71x29mmV voltage relay outputs front measurements 77x35x20mm built-in depth 20mm protection IP55°C display 3 digits		
	<b>No.</b>	379784	<b>Ref. No.</b> —
	temperature probe NTC 2kOhm cable thermoplastic probe -40 up to +110°C cable -40 up to +110°C probe ø6x35mm cable length 2m without screw connection 2-wire resistor 2kOhm		
	<b>No.</b>	403459	<b>Ref. No.</b> —
	connection cable LAE type FC06-20M01		

			
<b>No.</b>	379498	<b>Ref. No.</b>	00-555206
<b>description</b>	electronic controller LAE type SMD12RU20 mounting measurements 71x29mm display 3 digits		

miscellaneous

refrigeration controllers

			
<b>No.</b>	403414	<b>Ref. No.</b>	00-554478
<b>description</b>	electronic controller FOSTER mounting measurements 160x120x55mm		



## probes

### universal probes

#### temperature probes



<b>No.</b>	378454	<b>Ref. No.</b>	00-556293
<b>description</b>	temperature probe NTC 2kOhm cable thermoplastic probe -40 up to +110°C cable -40 up to +110°C probe ø6x28mm cable length 2.5m 2-wire		



<b>No.</b>	378453	<b>Ref. No.</b>	00-555124
<b>description</b>	temperature probe NTC 10kOhm cable thermoplastic probe -40 up to +110°C cable -40 up to +110°C probe ø6x14mm cable length 7m 2-wire		

### producer-specific probes

#### probes



<b>No.</b>	378451	<b>Ref. No.</b>	00-554473 00-554474
<b>description</b>	surface probe PTC 1kOhm cable PVC probe -50 up to +150°C cable -10 up to 100°C connection plug thread probe ø6x35mm cable length 1.5m		

#### core probes



<b>No.</b>	378452	<b>Ref. No.</b>	00-554451
<b>description</b>	core temperature probe NTC 2kOhm cable PVC probe -40 up to +120°C cable -10 up to 100°C connection 2-wire probe ø6x155mm thread cable length 1.5m handle ømm handle length 50mm		

## electronics

### PCBs



<b>No.</b>	403569	<b>Ref. No.</b>	01-275719-01
<b>description</b>	display L 140mm W 65mm type FD1-11/14		

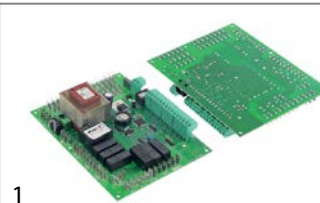

<b>No.</b>	360624	<b>Ref. No.</b>	00-555395
<b>description</b>	PCB blast freezer RBC20-60 L 185mm W 135mm suitable for FOSTER 115/230V		



<b>No.</b>	361932	<b>Ref. No.</b>	00-556242
<b>description</b>	PCB refrigerators and reffridgerator-freezers EPRO/EPREM L 100mm W 90mm suitable for FOSTER		

### central units



<b>No.</b>	403568	<b>Ref. No.</b>	16251036
<b>description</b>	control box L 195mm W 140mm type FD1-14		





## keypads

### keypad units



1

<b>No.</b>	403519	<b>Ref. No.</b>	00-554477
<b>description</b>	keypad freezer FST-FCC-DE2 buttons 4 cable length 2x1000mm suitable for FOSTER L 118mm W 68mm		



1

<b>No.</b>	403520	<b>Ref. No.</b>	15247078
<b>description</b>	keypad unit blast freezer blast freezer buttons 6 suitable for FOSTER L 445mm W 112mm		



1

<b>No.</b>	403517	<b>Ref. No.</b>	00-556020
<b>description</b>	keypad unit freezer FST-FCC-DE2 buttons 1 W ø80mm		

## solenoïd valves

### solenoïd valves (refrigeration)

CASTEL

valve bodies





STANDARD series

suitable for refrigerants R22, R134a, R404A, R407C, R410A, R507



1

<b>No.</b>	370382	<b>Ref. No.</b>	19863034	
<b>description</b>	solenoïd valve body NC type 1028/M10S p max 45bar connection 10mm soldering connection DN 3mm -35 up to +105°C L 125mm refrigeration straight CASTEL			
<b>accessories for</b>	370382			
	<b>No.</b>	371084	<b>Ref. No.</b>	—
<b>description</b>	solenoïd coil CASTEL 230VAC 8VA 50/60Hz connection cable 1000mm type CM2			

<b>accessories for</b>	370382			
	<b>No.</b>	371090	<b>Ref. No.</b>	—
<b>description</b>	power socket plug type DIN 43650A screw			
	<b>No.</b>	371301	<b>Ref. No.</b>	—
<b>description</b>	solenoïd coil CASTEL 110VAC 8VA 50/60Hz seat ø 11.5mm connection DIN 43650A type HF2			
	<b>No.</b>	371314	<b>Ref. No.</b>	—
<b>description</b>	solenoïd coil CASTEL 240VAC 8VA 50/60Hz seat ø 11.5mm			
	<b>No.</b>	371321	<b>Ref. No.</b>	—
<b>description</b>	solenoïd coil CASTEL 12/24VAC 50/60Hz seat ø 11.5mm connection DIN 43650A type HF2			

## compressors

### ACC/ZEL

R134A

HMBP monophase

High/Medium evaporation temperature above -20/-15 °C



1

<b>No.</b>	605008	<b>Ref. No.</b>	00-555464
<b>description</b>	compressor coolant R134a type GL80TB 220-240V 50Hz HMBP fully hermetic 9.5kg 1/5HP power input 554W cylinder capacity 7.6cm <sup>3</sup> CSIR H 175.5mm 165W 215W 290W 390W 500W 615W 727W 840W test method ASHRAE ambient temperature max. 43°C		



1

<b>No.</b>	605009	<b>Ref. No.</b>	00-555665
<b>description</b>	compressor coolant R134a type GL90TB 220-240V 50Hz HMBP fully hermetic 10.8kg 1/4HP power input 293W cylinder capacity 8.8cm <sup>3</sup> CSIR H 175.5mmW 143W 194W 259W 339W 432W 539W 661W 796W test method ASHRAE		



R404a/R507

LBP monophase

Lower evaporation temperature below -20°C



1

<b>No.</b>	605127	<b>Ref. No.</b>	00-555681
<b>description</b>	compressor coolant R404a/R507 type MX18FB 220-240V 50Hz LBP 17.3kg 5/8HP cylinder capacity 18.4cm <sup>3</sup> CSR H 230mm 575W 750W 985W 1219W 1498WWWWWW test method ASHRAE ambient temperature max. 43°C		

CUBIGEL

R404a/R507

HMBP monophase

High/Medium evaporation temperature above -20/-15 °C



1

<b>No.</b>	605013	<b>Ref. No.</b>	00-555671
<b>description</b>	compressor coolant R404a/R507 type ML60TB 220-240V 50Hz HMBP fully hermetic 10.1kg 1/4HP power input 647W cylinder capacity 5.68cm <sup>3</sup> CSIR H 175.5mmW 244W 319W 407W 511W 628W 760W 906W 1067W test method ASHRAE		

EMBRACO / ASPERA

R290A

LBP monophase

Lower evaporation temperature below -20°C



1

<b>No.</b>	605214	<b>Ref. No.</b>	00-556305
<b>description</b>	compressor coolant R290 type NEK2150U 220/240V 50Hz LBP 11.6kg 1/2HP cylinder capacity 13.54cm <sup>3</sup> CSIR H 206mm 403W 515W 650W 804W 979WWWWWW		



1

<b>No.</b>	605243	<b>Ref. No.</b>	00-570193
<b>description</b>	compressor coolant R290 type NEU2155U 220-240V 50Hz LBP 11.2kg 3/4HP cylinder capacity 13.54cm <sup>3</sup> CSIR H 190mm 463W 744W 916W 1110WWWWWW test method ASHRAE		

R404a/R507

LBP monophase

Lower evaporation temperature below -20°C



1

<b>No.</b>	605144	<b>Ref. No.</b>	00-556388
<b>description</b>	compressor coolant R404a/R507 type NEK2168GK 220-240V 50Hz LBP 22.9kg 3/4HP cylinder capacity 14.28cm <sup>3</sup> CSR H 200mm 345W 454W 587W 742W 921W 1123WWWWWW		





HMBP monophase

High/Medium evaporation temperature above -20/-15 °C



1

<b>No.</b>	605132	<b>Ref. No.</b>	00-556380
<b>description</b>	compressor coolant R404a/R507 type NT6222GK 200-240V 50Hz HMBP fully hermetic 17kg 1HP cylinder capacity 17.39cm <sup>3</sup> CSR H 252mmW 810W 1032W 1040W 1174W 1307W 1583W 2247W test method ASHRAE		
<b>accessories for</b>	605132		
	<b>No.</b>	365142	<b>Ref. No.</b> —
	operating capacitor capacity 15µF 450V with metal case tolerance 5% 50/60Hz ø 40mm L 110mm M8x1.25		
	<b>No.</b>	365153	<b>Ref. No.</b> —
	starting capacitor 52µF 330V 50/60Hz duty cycle 3s 41280A133 2252347 ø 36mm L 83mm M8 plastic connection cable 350mm		
	<b>No.</b>	390981	<b>Ref. No.</b> —
	klixon suitable for NT6222GK		

L'UNITE HERMETIQUE / TECUMSEH

R134A

HMBP monophase

High/Medium evaporation temperature above -20/-15 °C



1

<b>No.</b>	605137	<b>Ref. No.</b>	15422024
<b>description</b>	compressor coolant R134a type AEZ4430Y 220-240V 50Hz HMBP fully hermetic 10.2kg 1/4HP power input 330W cylinder capacity 8.8cm <sup>3</sup> CSIR H 199mmWW 245W 328W 432W 558W 698WW		

R404A

LBP monophase

Lower evaporation temperature below -20°C



1

<b>No.</b>	605157	<b>Ref. No.</b>	00-554691
<b>description</b>	compressor coolant R404A type CAJ2428Z 220-240V 50Hz LBP 21kg 5/8HP cylinder capacity 15.2cm <sup>3</sup> CSR H 271mm 434W 589W 773W 991W 1246WWWWWW		



1

<b>No.</b>	605238	<b>Ref. No.</b>	00-554685
<b>description</b>	compressor coolant R404A type CAJ2432Z 220-240V 50Hz LBP 21.5kg 5/8HP cylinder capacity 18.3cm <sup>3</sup> CSR H 271mm 542W 738W 971W 1247W 1567WWWWWW test method EN 12900 ambient temperature max. 32°C		

HMBP monophase

High/Medium evaporation temperature above -20/-15 °C



1

<b>No.</b>	605025	<b>Ref. No.</b>	00-599646
<b>description</b>	compressor coolant R404A type AE4430Z-FZ 220-240V 50Hz HMBP fully hermetic 10.2kg 1/4HP power input 427W cylinder capacity 5.7cm <sup>3</sup> CSIR H 186mmWW 258W 346W 441W 550W 682W 794W test method EN 12900 908W		
<b>spare parts for</b>	605025		
	<b>No.</b>	380061	<b>Ref. No.</b> —
	start relay MTRP0027-31 120/240V voltage AC 8A 1NO		



fans

refrigeration fans

refrigeration motors universal

miscellaneous



<b>No.</b>	601994	<b>Ref. No.</b>	15870041
<b>description</b>	fan motor 10W 240V 50Hz cable length 200mm FASCO AE1E5781K with capacitor bearing slide bearing		

accessories

fan wheels

aluminium

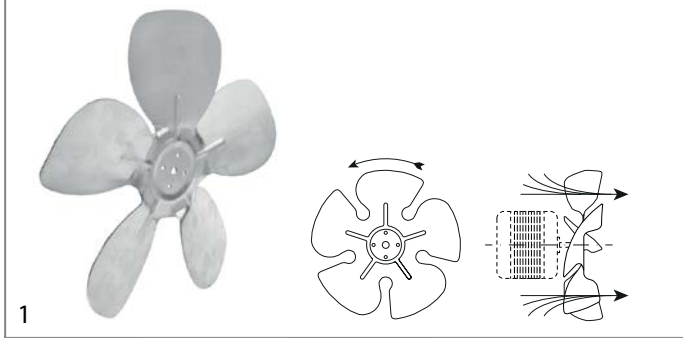

<b>No.</b>	601998	<b>Ref. No.</b>	15871021
<b>description</b>	fan wheel blowing ø 250mm fan wheel mounting 25.4mm blade angle 22° W 35mm aluminium		

cooling motors (complete)



<b>No.</b>	601997	<b>Ref. No.</b>	16250730
<b>description</b>	fan 230V 35W 50/60Hz fan wheel ø 220mm connection 3-wire cable length 1500mm 1300/1550rpm		



<b>No.</b>	605021	<b>Ref. No.</b>	15422012
<b>description</b>	compressor coolant R404A type AEZ4425Z 220-240V 50Hz HMBP fully hermetic 9.8kg 1/5HP cylinder capacity 4.5cm <sup>3</sup> CSIR H 186mmWW 198W 263W 341W 432W 537W 629W test method EN 12900 723W		



<b>No.</b>	605065	<b>Ref. No.</b>	00-554470
<b>description</b>	compressor coolant R404A type CAJ4519Z 220-240V 50Hz HMBP 24kg 1.5HP cylinder capacity 34.4cm <sup>3</sup> CSIR H 282mmWWW 1769W 2353W 3009W 3756W 4360W 5200W		

SECOP DANFOSS

R134A

HMBP monophase

High/Medium evaporation temperature above -20/-15 °C



<b>No.</b>	605077	<b>Ref. No.</b>	00-556062
<b>description</b>	compressor coolant R134a type SC15G 220-240V 50Hz HMBP fully hermetic 13.1kg 3/8HP cylinder capacity 15.3cm <sup>3</sup> CSIR H 203mmW 203W 358W 523W 703W 901W 1124W 1377W 1665W test method ASHRAEW 1993W		
<b>spare parts for</b>	605077		

<b>No.</b>	365062	<b>Ref. No.</b>	—
<b>description</b>	starting capacitor 80µF 220/300V 50/60Hz duty cycle 3min/1min ø 38mm L 98mm plastic connection cable 100mm		

<b>No.</b>	380078	<b>Ref. No.</b>	—
<b>description</b>	start relay DANFOSS 117U6005 HST		



1

<b>No.</b>	601996	<b>Ref. No.</b>	00-555495 00-570082 15470027
<b>description</b>	fan 230V 75W 50/60Hz fan wheel ø 250mm connection 3-wire cable length 1500mm 1300/1550rpm		



1

<b>No.</b>	602007	<b>Ref. No.</b>	00-599687
<b>description</b>	fan fan wheel ø 200mm 230V 50/60Hz 10W ø 250mm 1300/1550rpm connection 3-wire cable length 2000mm ELCO sucking		

**cold air circulating fans (complete)**

ebm-papst

A4E series

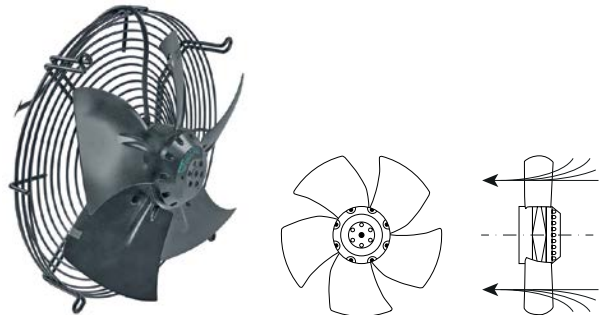

1

<b>No.</b>	601995	<b>Ref. No.</b>	00-554366
<b>description</b>	fan A4E300-AR26-16 fan wheel ø 300mm blades 5 230V 50Hz 70/95W 1380/1570rpm cable length 1400mm ebm-papst sucking		



1

<b>No.</b>	602008	<b>Ref. No.</b>	00-556010 00-570062 00-570202
<b>description</b>	fan fan wheel ø 200mm 230V 50/60Hz 10W ø 250mm 1400rpm connection 2-wire cable length 2000mm ELCO blowing		

**hot air fans**

ELCO



1

<b>No.</b>	602006	<b>Ref. No.</b>	00-554617
<b>description</b>	fan fan wheel ø 200mm 230V 50/60Hz 10W ø 250mm 1300/1550rpm connection 3-wire cable length 2000mm ELCO blowing		

ebm-papst



1

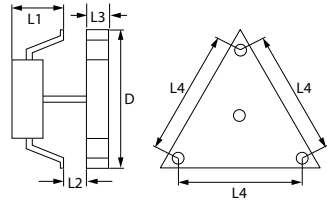

<b>No.</b>	601999	<b>Ref. No.</b>	00-554022
<b>description</b>	hot air fan 240V 28W 0.1A L1 65mm L2 17mm L3 28mm L4 157mm fan wheel ø 150mm ebm-papst type R2K150-AA03-10		

accessories universal

			
1			
<b>No.</b>	521075	<b>Ref. No.</b>	15872071
<b>description</b>	fanwheel cover L 350mm W 350mm hole distance 265mm		

equipment-specific units

for fridges

housing and bezels

covers

			
1			
<b>No.</b>	692562	<b>Ref. No.</b>	15350021
<b>description</b>	cover for pull handle L 295mm W 25mm plate thickness max. 3mm plastic Qty 1 pcs		

handles and hand wheels

bracket handles

			
1			
<b>No.</b>	690448	<b>Ref. No.</b>	15230221
<b>description</b>	pull handle L 402mm H 42mm mounting distance 375mm		

recessed handles

			
1			
<b>No.</b>	698553	<b>Ref. No.</b>	01-230376-01
<b>description</b>	door handle L 115mm W 55mm H 18mm mounting distance 60mm SS		

locks

locking devices

producer-specific

FOSTER

			
1			
<b>No.</b>	692553	<b>Ref. No.</b>	16230046
<b>description</b>	key cylinder kit		

			
1			
<b>No.</b>	692211	<b>Ref. No.</b>	15230366
<b>description</b>	locking device mounting distance 38mm		

walk-in fridge catches

CAFF/FERMOD



520/521 series



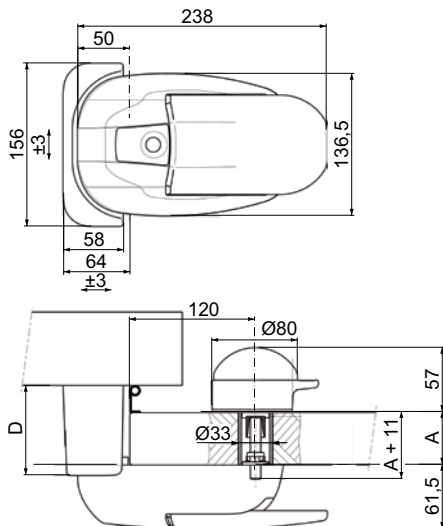

1





<b>No.</b>	701438	<b>Ref. No.</b>	00-570079
<b>description</b>	walk-in fridge catch door thickness 27-213mm L 238mm W 136.5mm H 61.5mm lockable type 521		
<b>spare parts for</b>	701438		
	<b>No.</b>	700618	<b>Ref. No.</b> 15230359
	door opener type 520/521/620/621/920/921 for door thickness 30-120mm		
<b>accessories for</b>	701438		
	<b>No.</b>	701472	<b>Ref. No.</b> —
	door catch W 58mm L 156mm H 52mm for off-set 27/43mm type 520/521		
	<b>No.</b>	701473	<b>Ref. No.</b> —
	door catch W 58mm L 156mm H 69mm for off-set 44/60mm type 520/521		
	<b>No.</b>	701474	<b>Ref. No.</b> —
	door catch W 58mm L 156mm H 86mm for off-set 61/77mm type 520/521		
	<b>No.</b>	701475	<b>Ref. No.</b> —
	door catch W 58mm L 156mm H 103mm for off-set 78/94mm type 520/521		



<b>accessories for</b>	701438		
	<b>No.</b>	701476	<b>Ref. No.</b> —
	door catch W 58mm L 156mm H 120mm for off-set 95/111mm type 520/521		
	<b>No.</b>	701477	<b>Ref. No.</b> —
	base plate W 58mm L 156mm H 17mm type 520/521		

<b>1</b>			
<b>No.</b>	700618	<b>Ref. No.</b>	15230359
<b>description</b>	door opener type 520/521/620/621/920/921 for door thickness 30-120mm		
<b>spare parts for</b>	700618		
	<b>No.</b>	701418	<b>Ref. No.</b> —
	lid ED ø 80mm green for door opener		

620/621 series

<b>1</b>			
<b>No.</b>	700618	<b>Ref. No.</b>	15230359
<b>description</b>	door opener type 520/521/620/621/920/921 for door thickness 30-120mm		
<b>spare parts for</b>	700618		
	<b>No.</b>	701418	<b>Ref. No.</b> —
	lid ED ø 80mm green for door opener		

920/921 series

<b>1</b>			
<b>No.</b>	700618	<b>Ref. No.</b>	15230359
<b>description</b>	door opener type 520/521/620/621/920/921 for door thickness 30-120mm		
<b>spare parts for</b>	700618		
	<b>No.</b>	701418	<b>Ref. No.</b> —
	lid ED ø 80mm green for door opener		

## hinges

### edgemount hinges

CHG

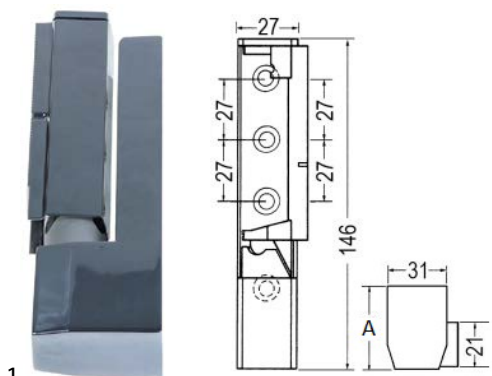

<b>No.</b>	690296	<b>Ref. No.</b>	00-555851
<b>description</b>	edgemount hinge L 146mm W 31mm mounting distance 27/27mm hinging left/right with gradient L1 45mm series R50		
<b>accessories for</b>	690296		
	<b>No.</b>	345323	<b>Ref. No.</b> —
microswitch with lever 250V 10A 1CO connection male faston ambient temperature max. 105°C			

### spring assisted hinges

#### producer-specific

FOSTER



<b>No.</b>	701460	<b>Ref. No.</b>	15230508
<b>description</b>	spring assisted hinge series FOSTER chrome-plated, polished L 136mm W 24mm door hinge left mounting distance 25mm metal		
<b>accessories for</b>	701460		
	<b>No.</b>	701459	<b>Ref. No.</b> 15230509
spring assisted hinge series FOSTER chrome-plated, polished L 136mm W 24mm door hinge right mounting distance 25mm metal			



<b>No.</b>	701459	<b>Ref. No.</b>	15230509
<b>description</b>	spring assisted hinge series FOSTER chrome-plated, polished L 136mm W 24mm door hinge right mounting distance 25mm metal		
<b>accessories for</b>	701459		
	<b>No.</b>	701460	<b>Ref. No.</b> 15230508
spring assisted hinge series FOSTER chrome-plated, polished L 136mm W 24mm door hinge left mounting distance 25mm metal			

## door bearing



<b>No.</b>	692552	<b>Ref. No.</b>	15230498
<b>description</b>	hinge bearing L 76mm W 24mm mounting distance 25.5mm shaft ø 7mm Qty 1 pcs		



<b>No.</b>	692555	<b>Ref. No.</b>	15230501
<b>description</b>	spring assisted hinge L 75mm W 25mm H 110mm mounting pos. upper and bottom Qty 2 pcs		

## pullouts

### drawer slides



<b>No.</b>	692561	<b>Ref. No.</b>	15230674
<b>description</b>	telescopic slide pair Qty 1 pair pcs L 550mm pull-out length 400mm SS		

## shelves and shelf rails

### grates

#### universal

#### without upstand



<b>No.</b>	970712	<b>Ref. No.</b>	15271429
<b>description</b>	grate W 325mm D 530mm GN 1/1 H 11mm plastic-coated steel wire gauge frame 9mm lengthwise wires gauge 4mm crossing wires 1 grey		





			
1			
<b>No.</b>	970871	<b>Ref. No.</b>	15271430
<b>description</b>	grate W 650mm D 530mm GN 2/1 plastic-coated steel wire gauge frame 9mm lengthwise wires gauge 3.7mm crossing wires 1 grey		

with upstand			
			
1			
<b>No.</b>	970873	<b>Ref. No.</b>	15271425
<b>description</b>	grate W 650mm D 530mm GN 2/1 H 41mm plastic-coated steel wire gauge frame 9mm lengthwise wires gauge 3.7mm crossing wires 1 grey		

## shelf rails and supports

universal			
			
1			
<b>No.</b>	690332	<b>Ref. No.</b>	00-556005
<b>description</b>	shelf support L 31/28mm W 22mm H 17mm SS with hook Qty 1 pcs		
<b>accessories for</b>	690332		
	<b>No.</b>	<b>Ref. No.</b>	—
	rack L 1000mm W 22mm H 4mm aperture 3x8mm hole distance 12.5mm stainless steel		

## producer-specific

			
1			
<b>No.</b>	692559	<b>Ref. No.</b>	00-745543-01
<b>description</b>	guide U-shape L 479mm W 25mm mounting pos. left/right inner height 12mm		

			
1			
<b>No.</b>	692558	<b>Ref. No.</b>	00-745542-01
<b>description</b>	guide U-shape L 580mm W 24mm H 12mm mounting pos. left/right		

			
1			
<b>No.</b>	692557	<b>Ref. No.</b>	01-233197-01
<b>description</b>	guide U-shape L 610mm W 25mm H 12mm mounting pos. left/right		

			
1			
<b>No.</b>	692560	<b>Ref. No.</b>	01-272911-01
<b>description</b>	guide U-shape L 636mm W 25mm mounting pos. left/right inner height 12mm		

			
1			
<b>No.</b>	692554	<b>Ref. No.</b>	01.255900-01
<b>description</b>	shelf support L 35/25mm W 19mm H 25mm SS Qty 1 pcs		

## gaskets

### refrigeration gaskets

#### plug-in gaskets

#### profile 9703

We offer custom-made gaskets for this profile

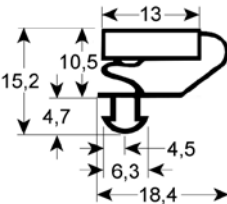
			
1			
<b>No.</b>	901663	<b>Ref. No.</b>	01-257028-01 15212214
<b>description</b>	refrigeration gasket profile 9703 W 595mm L 1515mm plug size		

profile 9195

We offer custom-made gaskets for this profile

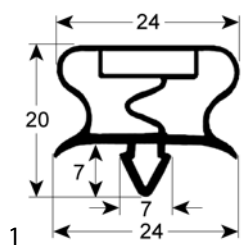

<b>No.</b>	901880	<b>Ref. No.</b>	01-231715-01
<b>description</b>	refrigeration gasket profile 9195 W 156mm L 379mm plug size		

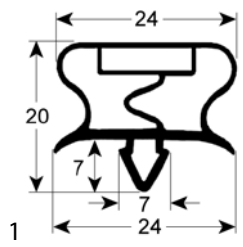

<b>No.</b>	901747	<b>Ref. No.</b>	01-231711-01
<b>description</b>	refrigeration gasket profile 9195 W 375mm L 610mm plug size		

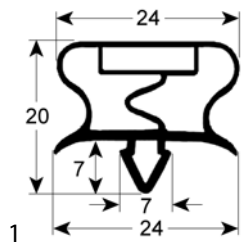

<b>No.</b>	901886	<b>Ref. No.</b>	01-231720-01
<b>description</b>	refrigeration gasket profile 9195 W 520mm L 685mm plug size		

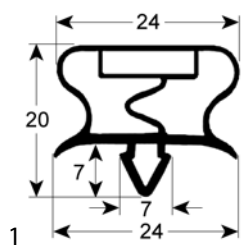

<b>No.</b>	901887	<b>Ref. No.</b>	01-232852-01
<b>description</b>	refrigeration gasket profile 9195 W 573mm L 1117mm plug size		

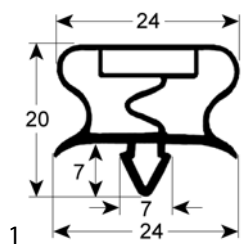

<b>No.</b>	901884	<b>Ref. No.</b>	01-232996-01
<b>description</b>	refrigeration gasket profile 9195 W 573mm L 351mm plug size		

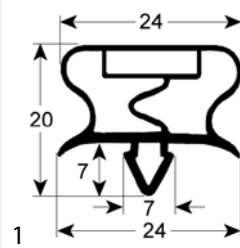

<b>No.</b>	901336	<b>Ref. No.</b>	01-231709-01
<b>description</b>	refrigeration gasket profile 9195 W 595mm L 1525mm plug size		

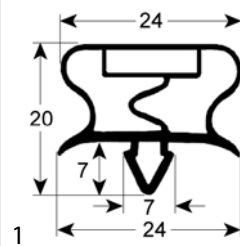

<b>No.</b>	901363	<b>Ref. No.</b>	01-231704-01
<b>description</b>	refrigeration gasket profile 9195 W 595mm L 721mm plug size		

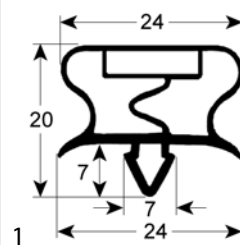

<b>No.</b>	901882	<b>Ref. No.</b>	01-231707-01
<b>description</b>	refrigeration gasket profile 9195 W 598mm L 1216mm plug size		

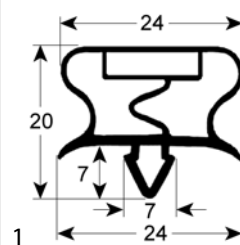

<b>No.</b>	901888	<b>Ref. No.</b>	01-232251-01
<b>description</b>	refrigeration gasket profile 9195 W 600mm L 684mm plug size		

profile 9171

We offer custom-made gaskets for this profile

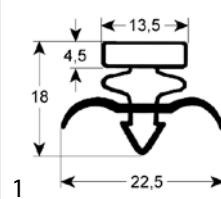

<b>No.</b>	901770	<b>Ref. No.</b>	15210777
<b>description</b>	refrigeration gasket profile 9171 W 278mm L 406mm plug size for drawer		



<b>No.</b>	901287	<b>Ref. No.</b>	15211775
<b>description</b>	refrigeration gasket profile 9171 W 390mm L 625mm plug size		

<b>No.</b>	901883	<b>Ref. No.</b>	15210783
<b>description</b>	refrigeration gasket profile 9171 W 496mm L 526mm plug size		

<b>No.</b>	901771	<b>Ref. No.</b>	15210778
<b>description</b>	refrigeration gasket profile 9171 W 406mm L 164mm plug size for drawer		

<b>No.</b>	901889	<b>Ref. No.</b>	15211805
<b>description</b>	refrigeration gasket profile 9171 W 508mm L 712mm plug size		

<b>No.</b>	901421	<b>Ref. No.</b>	15210775
<b>description</b>	refrigeration gasket profile 9171 W 410mm L 620mm plug size		

<b>No.</b>	901890	<b>Ref. No.</b>	15210737
<b>description</b>	refrigeration gasket profile 9171 W 526mm L 1420mm plug size		

<b>No.</b>	901665	<b>Ref. No.</b>	15211800
<b>description</b>	refrigeration gasket profile 9171 W 422mm L 593mm plug size		

<b>No.</b>	901199	<b>Ref. No.</b>	15210764
<b>description</b>	refrigeration gasket profile 9171 W 550mm L 1344mm plug size		

<b>No.</b>	901772	<b>Ref. No.</b>	15210779
<b>description</b>	refrigeration gasket profile 9171 W 474mm L 523mm plug size		

<b>No.</b>	901395	<b>Ref. No.</b>	15211731
<b>description</b>	refrigeration gasket profile 9171 W 585mm L 1555mm plug size		

<b>No.</b>	901633	<b>Ref. No.</b>	15210780
<b>description</b>	refrigeration gasket profile 9171 W 480mm L 730mm plug size		

<b>No.</b>	901664	<b>Ref. No.</b>	15211734
<b>description</b>	refrigeration gasket profile 9171 W 585mm L 745mm plug size		

<b>No.</b>	901184	<b>Ref. No.</b>	15211732
<b>description</b>	refrigeration gasket profile 9171 W 595mm L 1310mm plug size		

<b>No.</b>	901422	<b>Ref. No.</b>	15211751
<b>description</b>	refrigeration gasket profile 9171 W 770mm L 1830mm plug size		

<b>No.</b>	901420	<b>Ref. No.</b>	15210770
<b>description</b>	refrigeration gasket profile 9171 W 610mm L 620mm plug size		

<b>No.</b>	902270	<b>Ref. No.</b>	N/A
<b>description</b>	refrigeration gasket profile 9171 Wmm L 2500mm		

<b>No.</b>	901773	<b>Ref. No.</b>	15211794
<b>description</b>	refrigeration gasket profile 9171 W 615mm L 495mm plug size		

### door seal rails

<b>No.</b>	901892	<b>Ref. No.</b>	00-879086-01
<b>description</b>	gasket support L 40mm W 1490mm grey		

<b>No.</b>	901885	<b>Ref. No.</b>	15211770
<b>description</b>	refrigeration gasket profile 9171 W 621mm L 587mm plug size		

<b>No.</b>	901891	<b>Ref. No.</b>	00.879085-01
<b>description</b>	gasket support L 40mm W 570mm grey		

<b>No.</b>	901748	<b>Ref. No.</b>	15211789
<b>description</b>	refrigeration gasket profile 9171 W 730mm L 1540mm plug size for fridge		

### special gaskets

#### miscellaneous

<b>No.</b>	512422	<b>Ref. No.</b>	01-231852-16
<b>description</b>	thermal break suitable for FOSTER L 580mm W 360mm size kit metal thickness 1mm		

<b>No.</b>	901419	<b>Ref. No.</b>	15210767
<b>description</b>	refrigeration gasket profile 9171 W 730mm L 1790mm plug size		



## refrigeration cycle components

### valves

#### expansion valves

DANFOSS

#### valves

type TS2/TES2



1

<b>No.</b>	750530	<b>Ref. No.</b>	81453620/0
<b>description</b>	expansion valve DANFOSS type TS2 coolant R404a/R507 angled nozzle 068-2006 inlet 3/8" SAE outlet 1/2" SAE p max 34bar -30 up to +10°C capillary pipe 1500mm		

### filter driers

GMC



1

<b>No.</b>	750086	<b>Ref. No.</b>	19300357/0
<b>description</b>	dryer type SC032S connection ODF 1/4"-ODM 3/8" 50cm <sup>3</sup> p max 45bar -40 up to +80°C 261g total length 95mm ø 57.5mm		

### miscellaneous



1

<b>No.</b>	750501	<b>Ref. No.</b>	15480908
<b>description</b>	dryer ø 17.5mm L 110mm connection 8,2/7,7mm Qty 1 pcs		

## evaporators

### for fridges

#### producer-specific



1

<b>No.</b>	750503	<b>Ref. No.</b>	00-878253-02
<b>description</b>	evaporator L 550mm W 200mm H 70mm suitable for FOSTER		



1

<b>No.</b>	750504	<b>Ref. No.</b>	15463031 F15463031
<b>description</b>	evaporator L 700mm W 250mm H 190mm suitable for FOSTER		

## evaporation and condensing trays

### unheated condensing trays



1

<b>No.</b>	750502	<b>Ref. No.</b>	15271004
<b>description</b>	condensing tray L 258mm W 136mm H 60.5mm plastic		